

Therwell

INSTRUCTION MANUAL
MODEL 149
MILLI-MICROVOLTMETER

WARRANTY

We warrant each of our products to be free from defects in material and workmanship. Our obligation under this warranty is to repair or replace any instrument or part thereof which, within a year after shipment, proves defective upon examination. We will pay domestic surface freight costs.

To exercise this warranty, call your local field representative or the Cleveland factory, DDD 216-248-0400. You will be given assistance and shipping instructions.

REPAIRS AND RECALIBRATION

Keithley Instruments maintains a complete repair service and standards laboratory in Cleveland, and has an authorized field repair facility in Los Angeles and in all countries outside the United States having Keithley field representatives.

To insure prompt repair or recalibration service, please contact your local field representative or the plant directly before returning the instrument.

Estimates for repairs, normal recalibrations, and calibrations traceable to the National Bureau of Standards are available upon request.

TABLE OF CONTENTS

Section	Page	Section	Page
1. INTRODUCTION	1-1	4. MAINTENANCE.	4-1
Specifications	1-2	Trouble-Shooting	4-1
2. OPERATION.	2-1	Excessive Output Noise	4-1
Operating Controls	2-1	Output not Zero with Input	
Preliminary Set-Up	2-1	Terminals Shorted	4-2
General Precautions.	2-2	220-Volt Operation	4-3
Measuring Voltage.	2-3	5. REPLACEABLE PARTS.	5-1
Other Applications	2-4	Replaceable Parts List	5-1
3. CIRCUIT DESCRIPTION.	3-1	How to Order Parts	5-1
Input Circuit.	3-1	Model 149 Replaceable Parts List .	5-2
AC Amplifier	3-1	Models 1483, 1484 Replaceable	
DC Amplifier	3-1	Parts List.	5-6
Zero Suppression	3-2	Model 1491 Replaceable Parts List.	5-7
Other Controls	3-2	Model 1501 Replaceable Parts List.	5-7
Power Supply	3-2	Model 1502 Replaceable Parts List.	5-7
		Voltage and Resistance Chart . . .	5-9
		Schematic Diagram.	5-11
		Green Repair and Calibration Form.	5-13
		* Change Notice	Last Page

* Yellow Change Notice sheet is included only for instrument modifications affecting the Instruction Manual.

SECTION 1. INTRODUCTION

1-1. GENERAL.

a. The Model 149 Milli-Microvoltmeter is a stable, versatile instrument for measuring low-level dc signals. It functions as a voltmeter from 100 nanovolts full scale to 100 millivolts. It also operates as a dc amplifier with gains up to 10^8 for driving recorders.

b. The low noise level of the Model 149, together with its long-term stability, makes it ideal for many measurements requiring extreme power sensitivity.

c. Typical applications include measuring the output from strain gages, thermopiles, thermocouples, bolometers, phototubes, ionization chambers, scintillation counters, and barrier layer cells. Other applications are found in cell studies, measurement of electrochemical potentials, electrolytic corrosion studies, molecular weight analysis and Hall effect studies.

d. In addition to its use as a direct indicator of minute potentials and currents, the Model 149 may also be used as a null detector in Wheatstone or Mueller bridges.

e. An important feature of the instrument is zero suppression up to 100 times full scale in place of the usual more limited meter zero. This permits measurements of small signals in the presence of large thermal emf's or other masking dc signals.

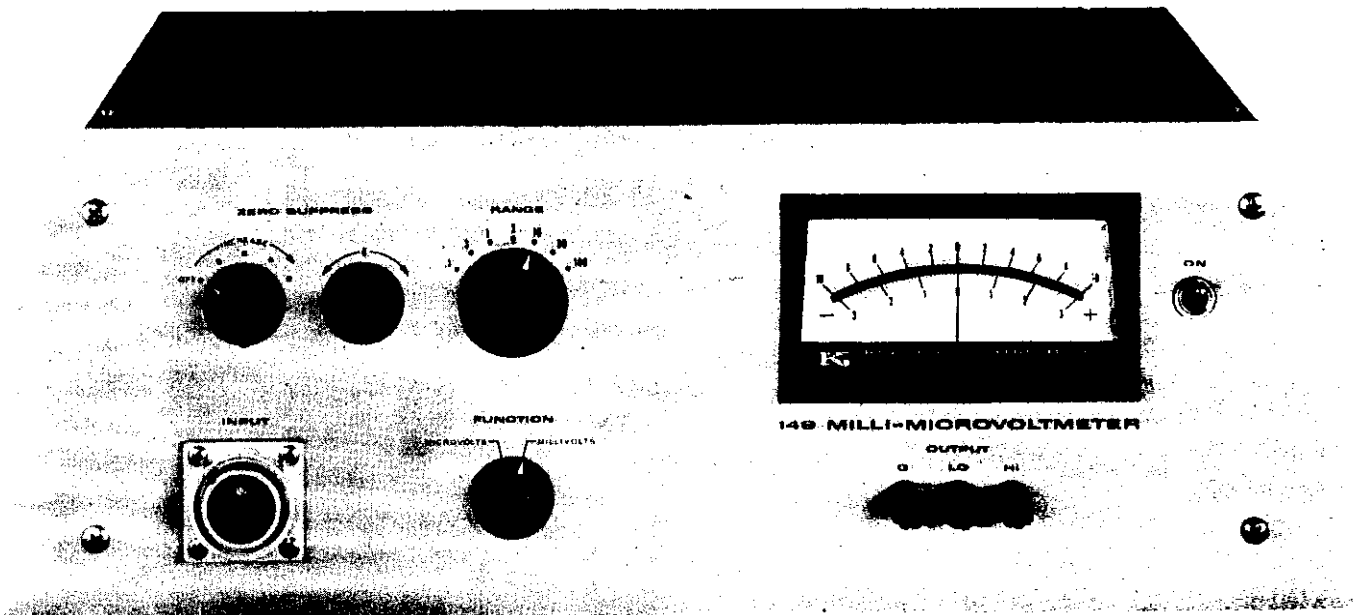

FIGURE 1. Keithley Instruments Model 149 Milli-Microvoltmeter.

1-2. SPECIFICATIONS.

RANGE: 0.1 microvolt (10×10^{-8} volt) full scale to 100 millivolts on zero-center meter. 13 overlapping ranges in 1x and 3x steps.

ACCURACY: $\pm 2\%$ of full scale on all ranges exclusive of noise and drift.

ZERO DRIFT: Less than 10 nanovolts per hour or less than 30 nanovolts in any 8-hour period after approximately 2-hour warm-up with reasonably constant ambient temperature. Long-term drift is non-cumulative.

INPUT NOISE (with input shorted): Less than 0.6 nanovolt rms (3 nanovolts peak-to-peak) on most sensitive range.

INPUT CHARACTERISTICS:

<u>Range</u>	<u>Input Resistance Greater than, ohms</u>	<u>Maximum Source¹ Resistance, ohms</u>
0.1 μV	10 k	100
0.3 μV	30 k	300
1.0 μV	100 k	1 k
3.0 μV	300 k	3 k
10.0 μV	1 M	10 k
30.0 μV	3 M	30 k
100 μV and above	10 M	30 k

Note:¹ Source resistances higher than the recommended maximum will increase noise and rise time.

LINE FREQUENCY REJECTION: Greater than 50:1 on the most sensitive range. (Ratio of impressed peak-to-peak line frequency voltage at input to indicated dc voltage.)

ISOLATION: Circuit ground to chassis ground: Approximately 10^9 ohms shunted by 0.05 microfarad. Circuit ground may be floated up to ± 400 volts with respect to chassis ground.

RISE TIME (10% to 90%):

0.1-microvolt Range: Less than 2 seconds when source resistance is less than 10% of maximum; 4 seconds using maximum source resistance.

0.3-microvolt to 100-millivolt Ranges: Less than 1 second when source resistance is less than 10% of maximum; 2 seconds using maximum source resistance.

ZERO SUPPRESSION: Up to at least 1 millivolt on the microvolt ranges and up to at least 10 millivolts on the millivolt ranges. Stability is such that 100 times full scale may be suppressed.

RECORDER OUTPUT:

Output: ± 10 volts dc at up to 5 milliamperes for full-scale meter deflection.

Resistance: Less than 10 ohms within the amplifier pass band.

Gain: $\frac{10 \text{ volts}}{\text{Range setting in volts}}$

Noise: Input noise times gain plus modulation products.

Modulation Products: Less than 2% peak-to-peak of full scale with input shorted.

CONNECTORS: Input: Special connector. Front Output: Binding posts. Rear Output: Amphenol 80-PC2F.

POWER: 105-125 or 210-250 volts, 60 cps, 50 watts. 50-cps models available.

DIMENSIONS, WEIGHT: 7 inches high x 19 inches wide x 13 inches deep; net weight, 24 pounds.

ACCESSORIES SUPPLIED: Model 1501 Low Thermal Input Cable with alligator clips; mating output connector; length of low-thermal solder.*

* The solder is screwed to the right side of the copper input chassis, located inside the Model 149. Remove the top cover to reach the solder.

SECTION 2 - OPERATIONA. OPERATING CONTROLS

The controls of the Model 149 are simple and conveniently placed. Their functions are as follows:

ON-OFF switch is located to the right of the panel meter.

FUNCTION switch selects the function which is to be used: Millivolts, or microvolts.

RANGE switch selects the full scale multiplier of the function selected by the FUNCTION switch.

ZERO SUPPRESS controls consists of the ZERO RANGE switch which selects the coarse range of suppressing voltage in discreet steps and the ZERO SET potentiometer which gives continuously variable fine control including settings through zero.

B. PRELIMINARY SET-UP

Connect the instrument to the power line. Unless otherwise marked the unit may be used on 117 volt, 60 cps line. To convert to 220-volt operation, refer to the MAINTENANCE section. A three-wire line cord is furnished, which grounds the cabinet. If a three-wire receptacle is not available, use the two-pin adapter furnished, and ground the third lead to an external ground.

Set controls as follows:

Function: Millivolts

Range: 100

Zero Suppress: OFF

Input: Short the input leads together.

C. GENERAL PRECAUTIONS

1. Source Resistance - In Section 1 under the Input Resistance Specification, the maximum source resistance for use with each voltage range is specified. Reasonable operation is possible with source resistance up to ten times greater than those specified, however, the measurement will suffer from a considerable decrease in speed of response, and measuring accuracy. If the instrument is left completely open-circuited, the meter will generally drift off scale on any range.

2. Shielding - Since the instrument operates with a modulator frequency of 120 cps, it is not generally sensitive to 60 cps pick-up unless it is large enough to overload the amplifier. The pickup may be a source of difficulty when using the amplifier with high impedances on the more sensitive voltage ranges. In these cases it is desirable to shield the leads and the sources as completely as possible. In some cases a simple low-pass filter at the input to eliminate frequencies of about 1 cps and above will be helpful. No use is made of an input filter in this instrument since any input series impedance due to the filter will increase the input noise and the thermal drift. When operating above ground, the case of the instrument must be grounded.

3. Determination of Excessive AC Pickup - A terminal attached to the output of the AC amplifier at the point of the demodulator is provided at the rear of the instrument. It is labeled DEMOD. OUTPUT. If an inability to make consistent readings persists, it is possible to check for the presence of excessive pick-up by observing the wave-form at this point. With the input shorted the picture should be approximately as shown in figure 2. If excessive pickup is observed it will look as shown in figure 3. The circuit will operate reasonably well as long as the wave-form does not clip as shown in figure 4. At this point the operation will be erratic.



FIGURE 2

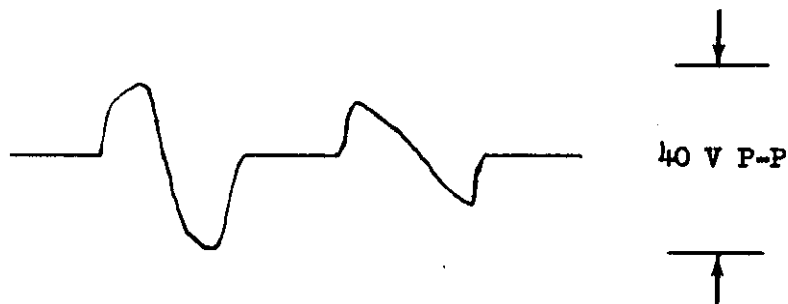

FIGURE 3

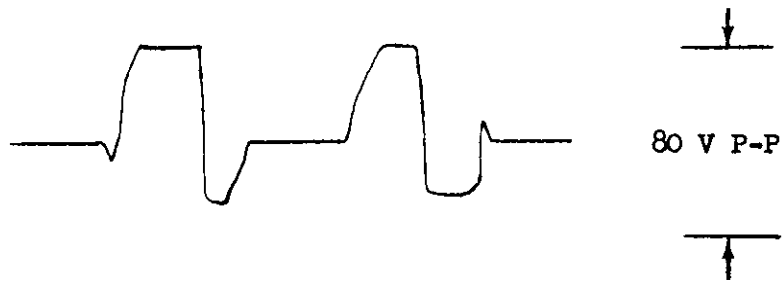

FIGURE 4

4. Thermal EMF - Extreme precautions have been taken in the input circuit to minimize thermal EMF's so the residual EMF is usually less than 0.5 uv. The material used in the input circuit is pure copper. Any other metal will generate a thermocouple potential. Lead solder is particularly troublesome. Where thermal EMF's are a problem, soldering should be done with the cadmium-tin solder supplied with the instrument.

5. Input Noise - The noise at the input is a function of input resistance and is approximately given by

$$E = 1.29 \times 10^{-10} \sqrt{(R+10)}$$

where E is the RMS noise, and R is the source resistance. It is assumed that the bandwidth of the instrument is about 1 cps and the temperature is 80° F. If noise is observed, calculate the theoretical noise and compare results. Also bear in mind that only wire-wound resistors approach the ideal resistor. However, if Evanohm or Manganin resistors are used, a considerable thermal EMF of the resistor material against copper will be observed.

6. Checking the Zero Point - At low levels, spurious EMF's may be generated simply by contact between the input leads and the terminals under test. If possible, always leave the instrument connected and adjust the zero after establishing a zero reference in the apparatus under test. For example, in bridge measurements, disconnect the bridge exciting voltage; or with a phototube, shield the tube from light.

7. Overloads - The current applied to the input circuit should be less than one milliamper dc steady state, 10 milliamperes dc short-term. When the FUNCTION switch is on the MILLIVOLTS position, the off-scale impedance can be as low as 1000 ohms. On the MICROVOLTS position, it may approach one ohm.

D. MEASURING VOLTAGE

1. Direct Voltage Measurements - Place the FUNCTION switch at MILLIVOLTS or MICROVOLTS as necessary for the measurement to be taken. Then turn the RANGE switch to more sensitive ranges until the meter gives a usable deflection.

2. Measuring Voltage Variations - To observe small variations in a large steady signal, first set the FUNCTION and RANGE switches as described in D 1. Then operate the ZERO SUPPRESS switch and potentiometer to reduce the meter deflection to zero. Increase the meter sensitivity with the range

switch. The stability of the suppression voltage is adequate for 100 x full scale suppression. Thus, if a thermocouple is supplying a signal of 10 millivolts to the Model 149 after suppressing the meter deflection to zero, the RANGE may set at 100 microvolts. If the 10 millivolt signal corresponds to a temperature of 250°C then after suppression variations of 2.5°C are seen full-scale.

3. Measuring Differential Voltages - When measurements are to be made in a circuit where the LOW connection is above ground potential, slide OUTPUT LINK from one of its posts. This disconnects the instrument circuit ground from chassis ground. DO NOT attempt to make such measurements where the side of the circuit being measured is more than 400 volts above external ground potential.

If a recorder is being used with the instrument in this arrangement, the recorder must not be grounded since the low side of the output is no longer being grounded.

The Keithley Model 370 Recorder is ideal for use with the Model 149 in recording operations. The Model 370 maximizes the performance of the Model 149 over the Milli-Microvoltmeter's entire range. The Model 370 can float ± 500 off ground.

E. OTHER APPLICATIONS

1. Null Indicator - The Model 149 makes an extremely sensitive null indicator which may be used in a wheatstone or Mueller Bridge.

If the bridge is arranged so than one terminal of the detector is grounded, the Model 149 may be used as described in D 1. If the detector must be used floating, remove the DISCONNECT LINK at the rear and observe the same precautions as in D 3.

SECTION 3 - CIRCUIT DESCRIPTION

The Model 149 is basically a narrow-band chopper amplifier employing negative feedback to stabilize the gain and increase the input impedance.

A. Input Circuit

Zero Stability: The effect of thermal EMF's generated in the input circuitry is reduced to nearly the vanishing point by the use of only copper in the input circuit. All solder points are made with a low thermal cadmium-tin solder. The chopper and chopper transformer employ copper leads. All switching in the input circuit is accomplished with copper switch. Critical resistors in the input circuit are wound of copper wire. The input connector has solid copper spring-loaded contacts.

The input voltage is applied to the moving arm of a 120 cps mechanical chopper. The feedback voltage is connected to the primary center tap of the input transformer. Thus, the difference voltage is applied first across one half of the primary and then, with phase reversal, to the other half. This full wave error signal is stepped up 90 to 1 by the input transformer and applied to the grid of V1, a 6084 low-noise pentode.

B. AC Amplifier

In parallel with the plate load resistor of V1 is a relatively high Q, 120 cps resonant circuit which narrows the bandwidth and reduces spurious signals.

V2 and V3, EF86 pentodes, further amplify the chopper error signal which is then demodulated synchronously by silicon diodes D1 through D4.

To obtain the 120 cps demodulator driving signal, use is made of the ripple frequency from a bridge rectifier circuit operating from the line voltage. The ripple is used in the primary of the demodulator driver transformer.

C. DC Amplifier

The demodulated signal is applied to the grid of V4. V4, V5, and V6 form the dc amplifier and output cathode follower which add further forward gain to the system and supply output power. Feedback around V4, V5 and V6 multiplies the effective capacitance of demodulator filter capacitor C113 by about 1000. This yields the large equivalent capacitance necessary to smooth the demodulated error signal. Because of the feedback, spurious noise in the dc stages outside the pass band of the whole amplifier are effectively degenerated.

D. Zero Suppression

A low-current ± 10 volt supply is derived from the main dc supplies using 10-volt zener diodes. Potentiometer R154 may be set at any voltage from -10 to +10 volts, this voltage is applied through appropriate dropping resistors to the feedback point to achieve zero suppression. The potentiometer is the front panel control marked ZERO SUPPRESS, while switch S3, which determines the portion feedback, is labeled ZERO SUPPRESS, OFF-INCREASE.

E. Other Controls

Two controls are set at the factory and should require only infrequent attention by the user.

R118 is an internal control marked DC AMP BAL. It is used to zero the DC amplifier, i.e., to set the output voltage to zero when the demodulator output is zero. This is not very critical since an unbalance will simply be fed back to the input to produce a small error signal to correct itself. R127 is marked CAL. This is the variable portion of the meter multiplier resistance to allow for meter-to-meter sensitivity differences.

F. Power Supply

A standard half-wave rectifier followed by an R-C filter is used to supply unregulated B+ and B- to the output cathode follower.

The unregulated B- is regulated to -150 volts in V7, OA2, and is used for the negative returns for the dc amplifier.

Unregulated B+ is fed to the plate of V8, 12B4A, the series tube in a 225-volt electronic regulator. The output voltage from this regulator is divided by R510 and R511 and compared to reference tube V9, a 5651. The difference signal is amplified by cascade amplifier V10, a 12AX7, and applied to the grid-cathode circuit of the series tube. This regulated 225 volts supplies B+ directly to the dc amplifier, through a decoupling filter (R176, C110) to the second and third ac amplifier stages, and through another decoupling filter (R103, C104) to the first ac amplifier stage.

Regulated B+ and B- also supply currents to the 10 volt zener diodes which are used for zero suppression. This gives two-stage regulation for these very critical voltages.

Zener Diode D112 regulates the filament voltage of V1 to reduce line transient effects.

SECTION 4 - MAINTENANCE

Except for occasional tube or chopper replacement, very little maintenance is required by the Model 149. Components are operated well below rating and solid state devices are employed where possible to achieve long, trouble-free service.

Certain portions of the input circuit are wired using chopper wire and special cadmium-tin solder. These special joints are painted red. If, for any reason, these joints must be unsoldered or re-soldered, USE ONLY CADMIUM-TIN SOLDER AND A COPPER-TIPPED SOLDERING IRON WHICH HAS NEVER BEEN USED WITH ORDINARY LEAD TIN SOLDER. A small spool of cadmium-tin solder is supplied with each instrument.

What may seem to be circuit failure in the millimicrovoltmeter is quite often found to be an unusual condition in the entire test set-up. Therefore, before trouble-shooting the instrument, check to see whether it operates correctly with:

1. All other circuitry disconnected.
2. Input shorted (with copper leads).
3. Power line voltage and frequency correct.

If the difficulty persists, the following systematic procedure may be employed to determine the fault.

TROUBLE-SHOOTING

Reference is made to the Schematic Diagram 13621D, and the Voltage-Resistance Diagram enclosed at the rear of the manual.

To begin trouble-shooting, short the input terminals, strap G to IO with the link provided, and switch ZERO SUPPRESS, OFF-INCREASE to OFF. A Zero offset of 0.1 to 0.4 microvolt is normal.

EXCESSIVE OUTPUT NOISE (INPUT TERMINALS SHORTED)

Because of the very low signal levels involved, noise in the ac amplifier is difficult to trace except by the substitution method. Most likely noise sources are V1 and the chopper. If noise persists after replacing the chopper, it is being generated in the dc amplifier or power supply. A stage-by-stage search should reveal the source. Very often the noise is generated by R102, low noise metal film resistor. Replace only with the equivalent resistor. Wire-wound resistors tend to introduce inductive pickup.

To replace the chopper, unplug the cap at the top. From the bottom of the Model 149, remove the plate covering the area around the chopper base. Unsolder the chopper leads. Clean out the lead at the input connector; tag the terminal for a correct connection later. Unscrew the chopper mounting screws and lift out the chopper from the top.

Insert the new chopper from the top, putting the wire leads through the holes. For convenience, place the No. 2 lead nearest the Model 149 side as shown in Figure 5. From the bottom, secure the chopper with four No. 4-40 NC-2 screws. Put approximately $3\frac{1}{2}$ in. of teflon tubing over lead No. 2 and $2\frac{1}{4}$ in. over the other two leads.

Solder lead No. 2 to the input connector. Insert a shorting bar into the input connector to push out the leads enough to facilitate working on the connection.

NOTE: Use soldering iron with a new solid copper tip and low-thermal cadmium solder for all solder connections painted red. This solder is supplied with the Model 149. Make sure of good electrical and mechanical connections.

Connect lead No. 1 to the red lead of transformer TR37; connect lead No. 3 to the blue lead of transformer TR37. Make loops at the lead ends, interlock the loops, and solder. Do not cross or twist the leads. Slide the tubing over the connections.

Twist shield lead V around chopper lead No. 2 as shown in Figure 5. Make sure the end of the shield lead is free of all contact. Replace the plate over the chopper base. Plug in the cap at the top of the chopper.

OUTPUT NOT ZERO (WITHIN 0.5 MICROVOLTS) WITH INPUT TERMINALS SHORTED

Be sure the ZERO SUPPRESS is set to OFF. Short the dc amplifier input grid, pin 7 of V4, to ground. Use the DC AMP BAL control to set the output to zero. The control will become very "scratchy" but the adjustment is possible. If this cannot be done, the dc amplifier or power supply are at fault. If it can be set to zero, the trouble may be in the ac amplifier or demodulator circuit.

a. Power Supply - B+ should be about +225 on pin 1 of V8, and B- should be -150 on pins 2, 4 or 7 of V7. If V7 is not firing, correct the fault in the unregulated B-. If +225 is not present, check for unregulated B+ (about 340 volts) at the plate pin 9 of V8. If the unregulated B+ is all right, check the tube pin voltages of V8, V9, and V10 to locate the faulty tube or part.

b. AC Amplifier - Remove the output tube (V6) and clip pin 1 of the output connector to ground. Place the FUNCTION switch on MILLIVOLTS, and turn the ZERO SET and ZERO RANGE controls full clockwise. This puts a large dc error

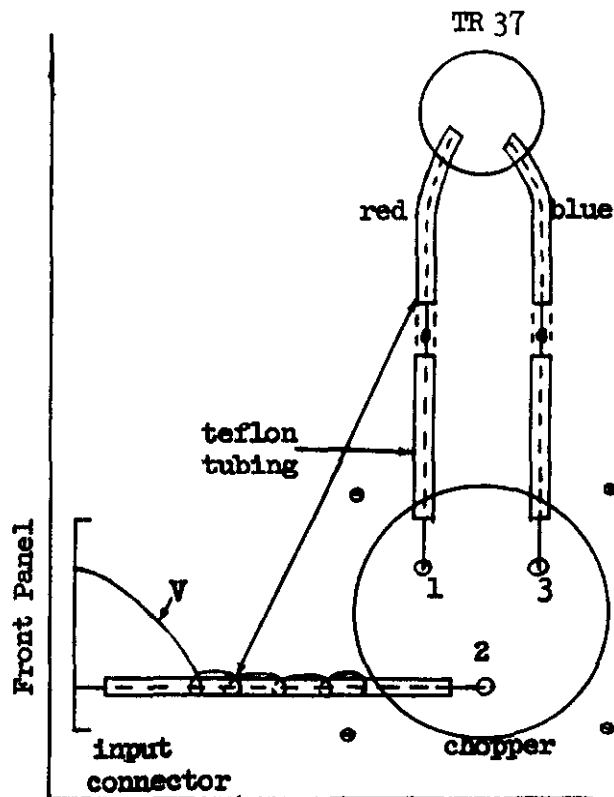

FIGURE 5. Chopper Replacement. View is from the bottom of Model 149.

signal across the chopper and input transformer. Use an oscilloscope to check for the presence of 120 cps at the primary of the input transformers (the two outside terminals on the chopper terminal block). Absence of signal means chopper failure (or much less likely, a shorted or open input transformer). Listen for audible chopper action and check chopper drive, if necessary.

If the 120 cps signal is present, check stage-by-stage throughout the ac amplifier, reducing the input signal as desired by backing off the ZERO RANGE and/or ZERO SET controls, until the failure is discovered.

d. Demodulator Circuit - Check for presence of about 80 volts RMS at the secondary of the demodulator transformer (at the ends of R113 and R114).

The tests outlined above will not suffice to pin-point every fault which may exist. They should, however, lead to the correction of common failures. In the event that troubles cannot be corrected by these means, or the user finds it more expedient, the unit may be returned to the factory for repair and recalibration at a nominal cost.

220-VOLT OPERATION

For 220-volt operation the power transformer primary connections must be changed. The jumpers connecting black and black-white together and blue and blue-white should be removed. The blue and black-white leads should be tied together. Replace the 1.5-ampere fuse (Keithley Part No. FU-8) with a 0.75-ampere fuse (Keithley Part No. FU-14).

SECTION 5. REPLACEABLE PARTS

5-1. REPLACEABLE PARTS LIST. The Replaceable Parts List describes the components of the Model 149 and its accessories. The List gives the circuit designation, the part description, a suggested manufacturer, the manufacturer's part number and the Keithley Part Number. The name and address of the manufacturers listed in the "Mfg. Code" column are contained in Table 3.

5-2. HOW TO ORDER PARTS.

a. For parts orders, include the instrument's model and serial number, the Keithley Part Number, the circuit designation and a description of the part. All structural parts and those parts coded for Keithley manufacture (80164) must be ordered from Keithley Instruments, Inc. In ordering a part not listed in the Replaceable Parts List, completely describe the part, its function and its location.

b. Order parts through your nearest Keithley distributor or the Sales Service Department, Keithley Instruments, Inc.

amp	ampere	Mfg.	Manufacturer
		MtF	Metal Film
CbVar	Carbon Variable	My	Mylar
CerD	Ceramic, Disc		
Coml	Commercial	Ω	ohm
Comp	Composition		
		p	pico (10^{-12})
DCb	Deposited Carbon	PM	Paper, metal cased
		Poly	Polystyrene
ETB	Electrolytic, tubular		
		μ	micro (10^{-6})
f	farad	v	volt
hy	henry	Var	Variable
k	kilo (10^3)	w	watt
		WW	Wirewound
M or meg	mega (10^6) or megohms	WWVar	Wirewound Variable
m	milli (10^{-3})		

TABLE 2. Abbreviations and Symbols.

MODEL 149 REPLACEABLE PARTS LIST

(Refer to Schematic Diagram 13621D for circuit designations.)

CAPACITORS

Circuit Desig.	Value	Rating	Type	Mfg. Code	Mfg. Part No.	Keithley Part No.
C101	Not Used					
C102	4.7 μ f	10 v	ETB	05397	K4R7J10S	C71-4.7M
C103	0.1 μ f	400 v	My	14655	WMF4P1	C114-.1M
C104	20 μ f	450 v	ETB	56289	TVA1709	C8-20M
C105	0.1 μ f	400 v	My	14655	WMF4P1	C114-.1M
C106 (60cps)	0.0082 μ f	100 v	Poly	84171	PE-822J	C45-.0082M
C106 (50cps)	0.0122 μ f	100 v	Poly	84171	PE-123J	C45-.0122M
C107	4.7 μ f	10 v	ETB	05397	K4R7J10S	C71-4.7M
C108	0.01 μ f	1000 v	CerD	72982	811Z5V103P	C22-.01M
C109	0.1 μ f	400 v	My	14655	WMF4P1	C114-.1M
C110	20 μ f	450 v	ETB	56289	TVA1709	C8-20M
C111	4.7 μ f	10 v	ETB	05397	K4R7J10S	C71-4.7M
C112	0.1 μ f	400 v	My	14655	WMF4P1	C114-.1M
C113	0.47 μ f	200 v	My	00656	V161	C29-.47M
C114	0.001 μ f	1000 v	CerD	72982	801Z5V102P	C22-.001M
C115 (60cps)	0.02 μ f	1000 v	CerD	72982	841Z5V203P	C22-.02M
C115 (50cps)	0.0047 μ f	100 v	Poly	84171	PE-472J	C45-.0047M
C116	0.001 μ f	1000 v	CerD	72982	801Z5V102P	C22-.001M
C117 (60cps)	*0.0047 μ f	1000 v	CerD	72982	811Z5V472P	C22-.0047M
C117 (50cps)	*0.0047 μ f	100 v	Poly	84171	PE-472J	C45-.0047M
C501	20 μ f	600 v	ETB	00656	PRS	C35-20M
C502	20 μ f	450 v	ETB	56289	TVA1709	C8-20M
C503	20 μ f	600 v	ETB	00656	PRS	C35-20M
C504	0.01 μ f	1000 v	CerD	72982	811Z5V103P	C22-.01M
C505	20 μ f	450 v	ETB	56289	TVA1709	C8-20M
C506	*0.5 μ f	600 v	My	14655	PKM6P5	C92-0.5M
C507	1000 μ f	15 v	ETB	72699	TD1000-15	C11-1000M
C508	Not Used					
C509	0.1 μ f	400 v	My	14655	WMF4P1	C114-.1M

DIODES

Circuit Desig.	Type	Number	Mfg. Code	Keithley Part No.
D101	Silicon	Matched Set	80164	14168A
D102	Silicon	Matched Set	80164	14168A
D103	Silicon	Matched Set	80164	14168A
D104	Silicon	Matched Set	80164	14168A
D105	Selenium	PT065	81483	RF-18

*Nominal value, factory set.

DIODES (Cont'd)

Circuit Desig.	Type	Number	Mfg. Code	Keithley Part No.
D106	Selenium	PT065	81483	RF-18
D107	Selenium	PT065	81483	RF-18
D108	Selenium	PT065	81483	RF-18
D109	Selenium	PT065	81483	RF-18
D110	Selenium	PT065	81483	RF-18
D111	Selenium Bridge	C1B	81483	RF-7
D112	Zener	1N1589	81483	DZ-4
D113	Zener	1N715	12954	DZ-22
D114	Zener	1N715	12954	DZ-22
D115	Selenium	PT065	81483	RF-18
D116	Selenium	PT065	81483	RF-18

MISCELLANEOUS PARTS

Circuit Desig.	Description	Mfg. Code	Keithley Part No.
F1 (115v)	Fuse, slow blow, 1.5 amp, 3 AG (Mfg. No. 31301.5)	75915	FU-8
F1 (230v)	Fuse, slow blow, 0.75 amp, 3 AG (Mfg. No. 313.750)	75915	FU-14
---	Fuse holder (Mfg. No. 342012)	75915	FH-3
G1 (60cps)	Chopper, Frequency Doubling	80164	CV-2
G1 (50cps)	Chopper, Frequency Doubling	80164	CV-3
J1	Receptacle Assembly, INPUT	80164	12450B
---	Plug, Special, Mate of J1	80164	13011B
J2	Jack, Telephone, DEMOD. TEST (Mfg. No. 275)	71002	CS-65
J3	Receptacle, Microphone, OUTPUT (Mfg. No. 80-PC2F)	02660	CS-32
---	Plug, Microphone, Mate of J3 (Mfg. No. 80-MC2M)	02660	CS-33
---	Binding Posts (2), OUTPUT, black (Mfg. No. DF21BC)	58474	BP-11B
---	Binding Post, OUTPUT, red (Mfg. No. DF21RC)	58474	BP-11R
---	Shorting Link (Mfg. No. 938-L)	24655	BP-6
L1	Choke, 200 hy	80164	CH-1
M	Meter	80164	ME-14
---	Meter Lamp (Mfg. No. 323)	08804	PL-1
---	Cord Set, 6 feet (Mfg. No. 4638-13)	93656	CO-5

MISCELLANEOUS PARTS (Cont'd)

Circuit Desig.	Description	Mfg. Code	Keithley Part No.
---	Cable Clamp (Mfg. No. SR-5P-1)	28520	CC-4
S1	Rotary Switch less components, FUNCTION	80164	SW-161
---	Switch Assembly with components, Function	80164	13728B
---	Skirted Knob, Function Switch	80164	KN-11
S2	Rotary Switch less components, RANGE	80164	SW-96
---	Switch Assembly with components, Range	80164	13727B
---	Skirted Knob, Range Switch	80164	KN-10
S3	Rotary Switch less components, ZERO SUPPRESS, Range	80164	SW-58
---	Switch Assembly, Zero Suppress, Range	80164	13726B
---	Skirted Knob, Zero Suppress Range Switch	80164	KN-11
---	Skirted Knob, Zero Suppress Set Potentiometer	80164	KN-17
S4	Toggle Switch, DPDT, ON (Mfg. No. 20905-FR)	04009	SW-14
T1	Transformer, Power	80164	TR-36
T2	Transformer, Filament	80164	TR-26
T3	Transformer, Chopper	80164	TR-37

RESISTORS

Circuit Desig.	Value	Rating	Type	Mfg. Code	Mfg. Part No.	Keithley Part No.
R101	33 k Ω	10%, 1/2 w	Comp	01121	EB	R1-33K
R102	2 M Ω	1%, 1 w	MtF	07716	MEF	R44-2M
R103	47 k Ω	10%, 1/2 w	Comp	01121	EB	R1-47K
R104	1 M Ω	1%, 1/2 w	DCb	79727	CFE-15	R12-1M
R105	3.3 M Ω	10%, 1/2 w	Comp	01121	EB	R1-3.3M
R106	1 M Ω	1%, 1/2 w	DCb	79727	CFE-15	R12-1M
R107	22 k Ω	10%, 1/2 w	Comp	01121	EB	R1-22K
R108	3.3 M Ω	10%, 1/2 w	Comp	01121	EB	R1-3.3M
R109	1 M Ω	1%, 1/2 w	DCb	79727	CFE-15	R12-1M
R110	22 k Ω	10%, 1/2 w	Comp	01121	EB	R1-22K
R111	1 M Ω	1%, 1/2 w	DCb	79727	CFE-15	R12-1M
R112	200 k Ω	1%, 1/2 w	DCb	79727	CFE-15	R12-200K
R113	100 k Ω	1%, 1/2 w	DCb	79727	CFE-15	R12-100K
R114	100 k Ω	1%, 1/2 w	DCb	79727	CFE-15	R12-100K
R115	*1 M Ω	1%, 1/2 w	DCb	79727	CFE-15	R12-1M
R116	470 k Ω	1%, 1/2 w	DCb	79727	CFE-15	R12-470K
R117	333 k Ω	1%, 1/2 w	DCb	79727	CFE-15	R12-333K
R118	500 k Ω	10%, 2 w	CbVar	01121	J	RP5-500K

*Nominal value, factory set.

RESISTORS (Cont'd)

Circuit Desig.	Value	Rating	Type	Mfg. Code	Mfg. Part No.	Keithley Part No.
R119	680 k Ω	1%, 1/2 w	DCb	79727	CFE-15	R12-680K
R120	3.33 M Ω	1%, 1/2 w	DCb	79727	CFE-15	R12-3.33M
R121	2.2 M Ω	1%, 1/2 w	DCb	79727	CFE-15	R12-2.2M
R122	62 k Ω	1%, 1/2 w	DCb	79727	CFE-15	R12-62K
R123	100 k Ω	1%, 1/2 w	DCb	79727	CFE-15	R12-100K
R124	1.3 M Ω	1%, 1/2 w	DCb	79727	CFE-15	R12-1.3M
R125	1 M Ω	1%, 1/2 w	DCb	79727	CFE-15	R12-1M
R126	30 k Ω	5%, 10 w	WW	63743	10F	R5-30K
R127	10 k Ω	10%, 2 w	WWVar	71450	WP	RP9-10K
R128	95.3 k Ω	1%, 1 w	MtF	07716	CEC	R94-95.3K
R129	1 Ω	1%	WW	80164		**R18-18-1
R130	1 k Ω	1%	Special WW Special	80164		**R18-18-1K
R131	111 Ω	1/4%, 1/3 w	WWenc Special	01686	7010	R105-111
R132	10 k Ω	5%	WW Special	80164		R18-18-10K
R133	100 k Ω	10%, 1/2 w	Comp	01121	EB	R1-100K
R134	10 M Ω	1%, 1/2 w	DCb	79727	CFE-15	R12-10M
R135	3.33 M Ω	1%, 1/2 w	DCb	79727	CFE-15	R12-3.33M
R136	1 M Ω	0.5%, 1/2 w	MtF	07716	CEC	R61-1M
R137	333 k Ω	0.5%, 1/2 w	MtF	07716	CEC	R61-333K
R138	100 k Ω	0.5%, 1/2 w	MtF	07716	CEC	R61-100K
R139	33.2 k Ω	0.5%, 1/2 w	MtF	07716	CEC	R61-33.2K
R140	9.9 k Ω	0.5%, 1/2 w	MtF	07716	CEC	R61-9.9K
R141	220 k Ω	10%, 1/2 w	Comp	01121	EB	R1-220K
R142	100 k Ω	10%, 1/2 w	DCb Special	80164		R38-100K
R143	1.5 M Ω	10%, 1/2 w	Comp	01121	EB	R1-1.5M
R144	*150 k Ω	10%, 1/2 w	Comp	01121	EB	R1-150K
R145	*150 k Ω	10%, 1/2 w	Comp	01121	EB	R1-150K
R146	*150 k Ω	10%, 1/2 w	Comp	01121	EB	R1-150K
R147	*33 k Ω	10%, 1/2 w	Comp	01121	EB	R1-33K
R148	3.9 k Ω	10%, 1/2 w	Comp	01121	EB	R1-3.9K
R149	*3.3 k Ω	10%, 1/2 w	Comp	01121	EB	R1-3.3K
R150	1 k Ω	1%, 1/2 w	DCb	79727	CFE-15	R12-1K
R151	1 M Ω	1%, 1/2 w	DCb	79727	CFE-15	R12-1M
R152	100 k Ω	1%, 1/2 w	DCb	79727	CFE-15	R12-100K
R153	9 k Ω	1%, 1/2 w	DCb	79727	CFE-15	R12-9K
R154	10 k Ω	3%, 5 w	WWVar	73138	A	RP4-10K
R155	30 k Ω	5%, 10 w	WW	63743	10F	R5-30K

*Nominal value, factory set.

**R129 and R130 are matched to 1/2%. Order as a pair.

RESISTORS (Cont'd)

Circuit Desig.	Value	Rating	Type	Mfg. Code	Mfg. Part No.	Keithley Part No.
R176	10 k Ω	10%, 1/2 w	Comp	01121	EB	R1-10K
R501	100 Ω	10%, 2 w	Comp	01121	HB	R3-100
R502	100 Ω	10%, 2 w	Comp	01121	HB	R3-100
R503	5 k Ω	5%, 10 w	WW	94310	FR-10	R5-5K
R504	5 k Ω	5%, 10 w	WW	94310	FR-10	R5-5K
R505	22 k Ω	10%, 2 w	Comp	01121	HB	R3-22K
R506	10 M Ω	10%, 1/2 w	Comp	01121	EB	R1-10M
R507	220 k Ω	1%, 1/2 w	DCb	79727	CFE-15	R12-220K
R508	33 k Ω	10%, 1/2 w	Comp	01121	EB	R1-33K
R509	33 k Ω	10%, 1/2 w	Comp	01121	EB	R1-33K
R510	1 M Ω	10%, 1/2 w	Comp	01121	EB	R1-1M
R511	600 k Ω	1%, 1/2 w	DCb	79727	CFE-15	R12-600K
R512	10 Ω	1%, 5 w	WW	91637	RS-5	R4A-10

VACUUM TUBES

Circuit Desig.	Number	Mfg. Code	Keithley Part No.
V1	***6084	80164	EV-6084/E80F
V2	***EF86	80164	EV-EF86/6267
V3	***EF86	80164	EV-EF86/6267
V4	***7025	80164	EV-ECC83/7025
V5	***12AT7	80164	EV-12AT7
V6	***6CM6	80164	EV-6CM6
V7	***OA2	80164	EV-OA2
V8	12B4A	85599	EV-12B4A
V9	***CK5651	80164	EV-CK5651
V10	7025	73445	EV-ECC83/7025

MODELS 1483, 1484 REPLACEABLE PARTS LIST

Description	Quantity	Mfg. Code	Keithley Part No.	Used on Kit Model
Crimp Tool for Copper lugs	1	80164	TL-1	1483
#8 Nylon Screws	50	80164	---	1483, 1484
#8 Nylon Hex Nuts	50	80164	---	1483, 1484
Copper Bolt-on Lugs	100	80164	17340 A	1483, 1484
Copper Spade Lugs	100	80164	17339 A	1483, 1484
Copper Hook Lugs	100	80164	17336 A	1483, 1484
Copper Splice Tubes	100	80164	17338 A	1483, 1484
Low-Thermal Cadmium-Tin Solder	10 feet	80164	---	1483, 1484
Copper Alligator Clips (Mfg. No. 6005)	10	76545	AC-9	1483, 1484

***Specially aged tubes.

MODELS 1483, 1484 REPLACEABLE PARTS LIST (Cont'd)

Description	Quantity	Mfg. Code	Keithley Part No.	Used on Kit Model
Shielded Cable	10 feet	80164	SC-5	1483, 1484
Insulated #20 Copper Wire	100 feet	80164	WS-1	1483, 1484
Non-metallic Abrasive	3 pads	80164	17774A	1483, 1484

MODEL 1491 REPLACEABLE PARTS LIST

Description	No. Required Per Model	Mfg. Code	Keithley Part No.
End Frames	2	80164	13120C
Fastener, Thumbscrew	4	80164	FA-9
Feet, Rubber	4	80164	FE-2

Attaching Parts

Machine Screw, No. 6-32UNC-2x1/2, Rd Hd, Phillips	4	Coml	---
Hex Nut, No. 6-32UNC-2	4	Coml	---

Machine Screw, No. 8-32UNC-2x5/16, Rd Hd, Phillips	4	Coml	---
--	---	------	-----

MODEL 1501 REPLACEABLE PARTS LIST

Description	Mfg. Code	Keithley Part No.
Plug Assembly	80164	13011B
Cable, 48 inches, Vinyl, shielded	86696	SC-5
Alligator Clamps, two (Mfg. No. 60C5)	76545	AC-8

MODEL 1502 REPLACEABLE PARTS LIST

Description	Mfg. Code	Keithley Part No.
Plug Assembly	80164	13011B
Cable, 10 feet, Vinyl, shielded	86696	SC-5

00011	Sylvania Electric Products, Inc. Buffalo Operations of Sylvania Electronic Systems Buffalo, N. Y.	02660	Amphenol-Borg Electronics Corp. Broadview, Chicago, Illinois
00656	Aerovox Corp. New Bedford, Mass.	04009	Arrow-Hart and Hegeman Electric Co. Hartford, Conn.
01121	Allen-Bradley Corp. Milwaukee, Wis.	05397	Kemet Co. Cleveland, Ohio
		07716	International Resistance Co. Burlington, Iowa

TABLE 3 (Sheet 1). Code List of Suggested Manufacturers. (Based on Federal Supply Code for Manufacturers, Cataloging Handbook H4-1.)

08804	Lamp Metals and Components Department G. E. Co. Cleveland, Ohio	75915	Littelfuse, Inc. Des Plaines, Ill.
12954	Dickson Electronics Corp. Scottsdale, Ariz.	76545	Mueller Electric Co. Cleveland, Ohio
14655	Cornell-Dubilier Electric Corp. Newark, N. J.	79727	Continental-Wirt Electronics Corp. Philadelphia, Pa.
24655	General Radio Co. West Concord, Mass.	80164	Keithley Instruments, Inc. Cleveland, Ohio
28520	Heyman Mfg. Co. Kenilworth, N. J.	81453	Raytheon Co. Industrial Components Div. Industrial Tube Operation Newton, Mass.
44655	Ohmite Mfg. Co. Skokie, Ill.	81483	International Rectifier Corp. El Segundo, Calif.
56289	Sprague Electric Co. North Adams, Mass.	83125	General Instrument Corp. Capacitor Division Darlington, S. C.
58474	Superior Electric Co., The Bristol, Conn.	83330	Smith, Herman H., Inc. Brooklyn, N. Y.
63743	Ward Leonard Electric Co. Mount Vernon, N. Y.	84171	Arco Electronics, Inc. Great Neck, N. Y.
71002	Birnbach Radio Co. New York, N. Y.	85599	Tube Department G. E. Co. Schenectady, New York
71450	CTS Corp. Elkhart, Ind.	86684	RCA Electron Tube Division of Radio Corp. of America Harrison, N. J.
72982	Erie Technological Products, Inc. Erie, Pa.	866 ⁰ 6	Radix Wire Co. Cleveland, Ohio
73138	Helipot Division of Beckman Instruments, Inc. Fullerton, Calif.	91637	Dale Electronics, Inc. Columbus, Nebr.
73445	Amperex Electronic Co. Division of North American Philips Co., Inc. Hicksville, N. Y.	93656	Electric Cord Co. Caldwell, N. J.
75042	International Resistance Co. Philadelphia, Pa.	94310	Tru Ohm Products Memcor Components Division Huntington, Ind.
		99942	Hoffman Electronics Corp. Semiconductor Division El Monte, Calif.

TABLE 3 (Sheet 2). Code List of Suggested Manufacturers. (Based on Federal Supply Code for Manufacturers, Cataloging Handbook H4-1.)

Part No.	Quantity	Notes
A	1	See Note 1
B	1	See Note 1
C	1	See Note 1

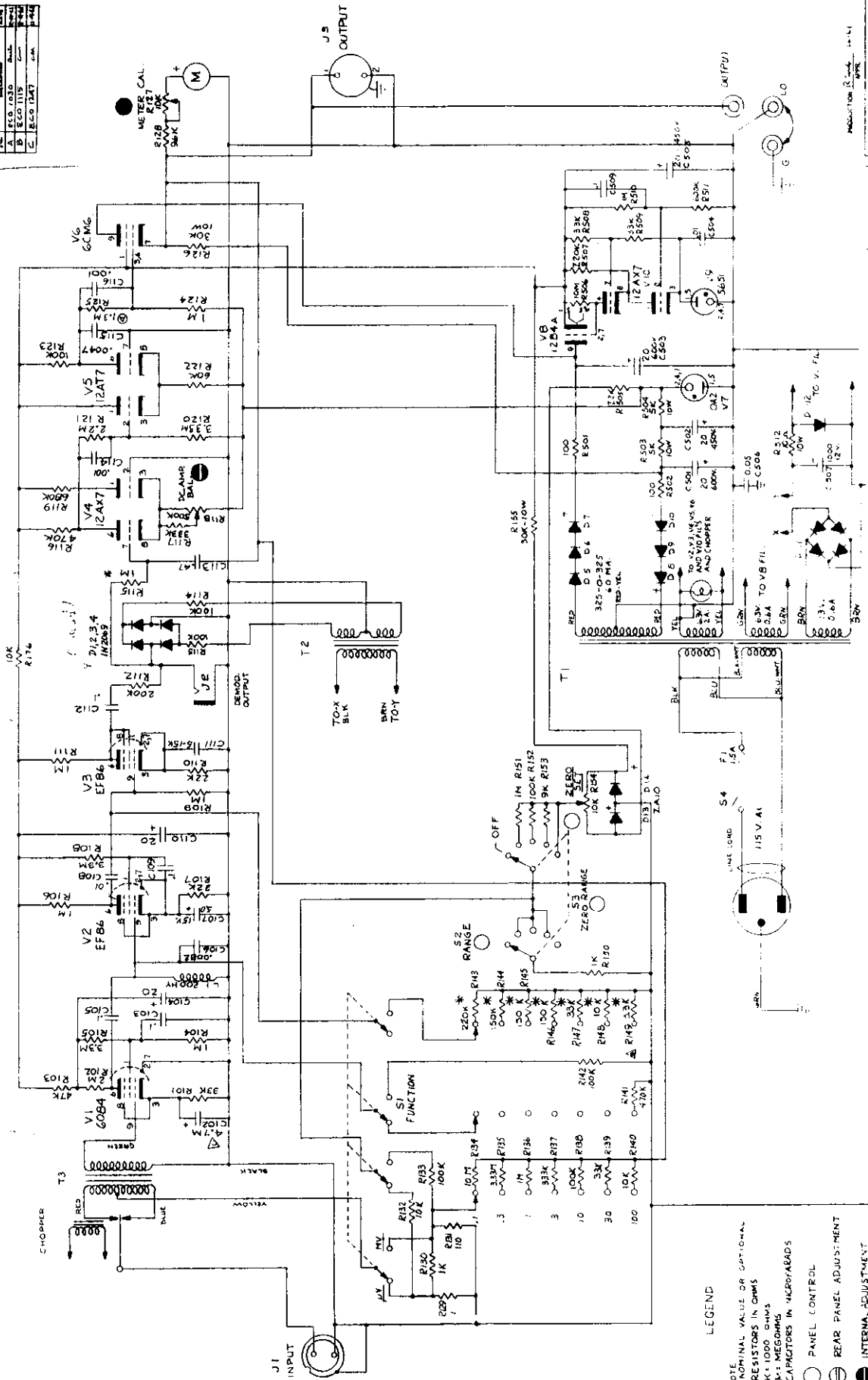

LEGEND

- * NOMINAL VALUE OR OPTIONAL
- RESISTORS IN OHMS
- K=1000 OHMS
- M= MEGOHMS
- CAPACITORS IN MICROFARADS
- PANEL CONTROL
- ⊖ REAR PANEL ADJUSTMENT
- INTERNAL ADJUSTMENT

MANUFACTURED BY
KEITHLEY INSTRUMENTS
 DIVISION OF
GENCO
 13621 D

Part No.	Quantity	Notes
A	1	See Note 1
B	1	See Note 1
C	1	See Note 1

CHANGE NOTICE

February 3, 1965

MODEL 149 MILLI-MICROVOLTMMETER

Page 1-2. Change the first sentence of the STABILITY Specification to the following:

After approximately 2-hour warm-up within 0.01 microvolt per hour or 0.03 microvolt in any 8-hour period with relatively constant ambient temperatures.

Page 5-3. Change to the following:

Circuit Desig.	Type	Number	Mfg. Code	Keithley Part No.
D113	Zener	1N715	12954	DZ-22
D114	Zener	1N715	12954	DZ-22

12954 is the manufacturer code for Dickson Electronics Corp., Scottsdale, Ariz.

CHANGE NOTICE

April 15, 1965

MODEL 149 MILLI-MICROVOLTMMETER

Page 5-2. Change to the following:

C115 (60 cps) 0.02 μ f 1000 v CerD 72982 841Z5V203P C22- .02M

Schematic Diagram 13621D.

Change the value of C115 to .02.

CHANGE NOTICE

June 17, 1966

MODEL 149 MILLI-MICROVOLTMETER

Page 2-3. Change the first sentence in paragraph 4 to read:

4. Thermal EMI-Extreme precautions have been taken in the input circuit to minimize thermal EMI's so the residual EMI is usually less than 0.5 μ v.

Page 5-2. Change to the following:

Circuit Desig.	Value	Rating	Type	Mfg. Code	Mfg. Part No.	Keithley Part No.
C104	20 μ f	450 v	ETB	56289	TVA1709	C8-20M
C110	20 μ f	450 v	ETB	56289	TVA1709	C8-20M
C502	20 μ f	450 v	ETB	56289	TVA1709	C8-20M
C505	20 μ f	450 v	ETB	56289	TVA1709	C8-20M

Page 5-6. Change to the following:

Circuit Desig.	Number	Mfg. Code	Keithley Part No.
V4	***7025	80164	EV-ECC83/7025
V10	***7025	80164	EV-ECC83/7025

Schematic Diagram 13621D:

Change the number of V4 and V10 to 7025

*** Specially aged tubes.

CHANGE NOTICE

November 3, 1966

MODEL 149 MILLI-MICROVOLTMETER

Page 5-2. Change to the following:

Circuit Desig.	Value	Rating	Type	Mfg. Code	Mfg. Part No.	Keithley Part No.
C105	0.1 μf	400 v	My	14655	WMF 4P1	C114-.1M
C112	0.1 μf	400 v	My	14655	WMF 4P1	C114-.1M
C509	0.1 μf	400 v	My	14655	WMF 4P1	C114-.1M

CHANGE NOTICE

MODEL 149 MILLI-MICROVOLTMETER

December 6, 1967

Page 1-2. INPUT CHARACTERISTICS: Change the last value in the - Maximum Source Resistance, ohms - column to 30k.

Change the RISE TIME Specification to:

RISE TIME (10% to 90%):

0.1 - microvolt Range: Less than 2 seconds when source resistance is less than 10% of maximum; 4 seconds using maximum source resistance.

0.3 - microvolt to 100 - millivolt Ranges: Less than 1 second when source resistance is less than 10% of maximum; 2 seconds using maximum source resistance.

Page 5-2. Change to the following:

Circuit Desig.	Value	Rating	Type	Mfg. Code	Mfg. Part No.	Keithley Part No.
C103	0.1 μ f	400 v	My	14655	WMF 4P1	C114-.1M

Page 5-5. Change to the following:

Circuit Desig.	Value	Rating	Type	Mfg. Code	Mfg. Part No.	Keithley Part No.
R131	111 Ω	1/4%, 1/3 w	WWenc	01686	7010	R105-111
R136	1 M Ω	0.5%, 1/2w	MtF	07716	CEC	R61-1M
R137	333 k Ω	0.5%, 1/2 w	MtF	07716	CEC	R61-333K
R138	100 k Ω	0.5%, 1/2 w	MtF	07716	CEC	R61-100K
R139	33.2 k Ω	0.5%, 1/2 w	MtF	07716	CEC	R61-33.2K
R140	9.9 k Ω	0.5%, 1/2 w	MtF	07716	CEC	R61-9.9K

Page 5-6, Models 1483, 1484 Replaceable Parts List. Change to the following:

Description	Quantity	Mfg. Code	Keithley Part No.	Used on Kit Models
Copper Bolt-on Lugs	100	80164	17340A	1483, 1484
Copper Spade Lugs	100	80164	17339A	1483, 1484
Copper Hook Lugs	100	80164	17336A	1483, 1484
Copper Splice Tubes	100	80164	17338A	1483, 1484

CHANGE NOTICE

February 21, 1968

MODEL 149 MILLI-MICROVOLTMETER

Page 5-5. Change to the following:

Circuit Desig.	Value	Rating	Type	Mfg. Code	Mfg. Part No.	Keithley Part No.
R141	220 k Ω	10%, 1/2 w	Comp	01121	EB	R1-220K
R143	1.5 M Ω	10%, 1/2 w	Comp	01121	EB	R1-1.5M
R148	3.9 k Ω	10%, 1/2 w	Comp	01121	EB	R1-3.9K

Add the following:

Circuit Desig.	Value	Rating	Type	Mfg. Code	Mfg. Part No.	Keithley Part No.
R156	1 M Ω	10%, 1/2 w	Comp	01121	EB	R1-1M
R157	330 k Ω	10%, 1/2 w	Comp	01121	EB	R1-330K

CHANGE NOTICE

April 16, 1969

MODEL 149 MILLI-MICROVOLTMETER

Page 5-2. Change to the following:

Circuit Desig	Type	Number	Mfg. Code	Keithley Part No.
D105	Silicon	1N3256	02735	RF-22
D106	Silicon	1N3256	02735	RF-22
D108	Silicon	1N3256	02735	RF-22
D109	Silicon	1N3256	02735	RF-22

VOLTAGE AND RESISTANCE CHART
 MODEL 149
 MEASUREMENTS FROM TUBE PIN TO GROUND USING VTVM WITH 100 MEG OHM
 INPUT RESISTANCE. FUNCTION SWITCH AT MILLIVOLTS, INPUT SHORTED,
 RANGE SWITCH AT 100Ω. ZEROS SUPPRESS OFF.
 ALL READINGS ARE APPROXIMATE.
 RESISTANCES ARE GIVEN IN OHMS; K=1000; M=MEG OHMS

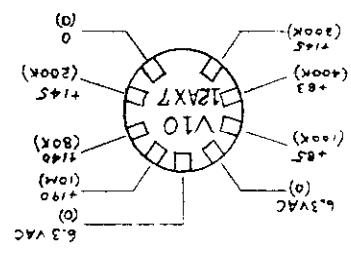
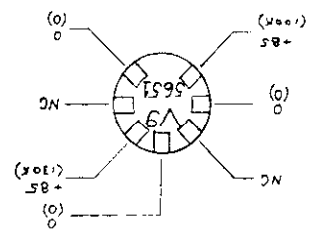
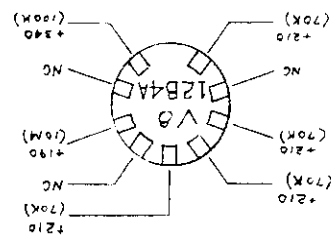
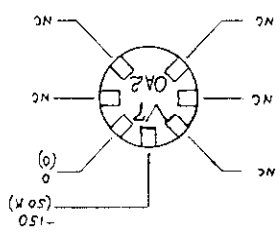
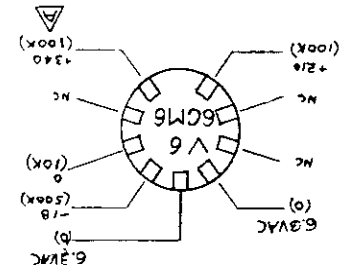
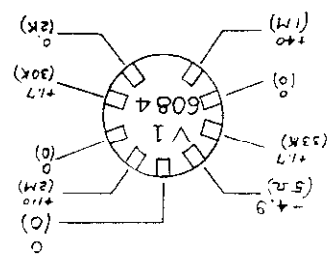

PC-22

